

# Robotic Pool Cleaner

## User Manual

English

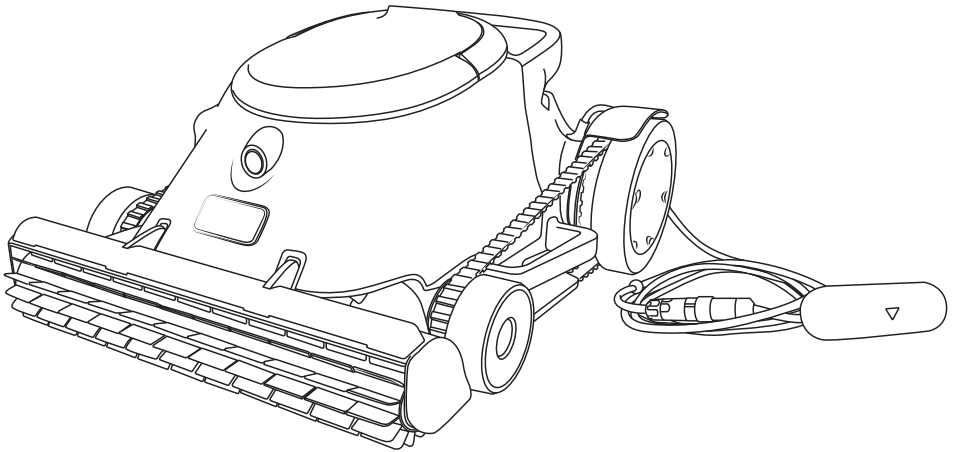

**Robotic Pool Cleaner**

---

# Content

<b>1. Safety Precautions</b>	<b>3</b>
1.1 Warning	3
1.2 Notes	3
1.3 Water quality conditions	4
<b>2. Product Unboxing</b>	<b>4</b>
2.1 Unboxing Checklist	4
2.2 Component Introduction	5
2.3 Product Specifications	6
<b>3. Initial Use</b>	<b>7</b>
3.1 Charging	7
3.2 Turn On/Off	7
3.3 Battery Level	8
3.4 Machine Water Entry	8
3.5 Auto Parking	10
3.6 Waterline Retrieval	10
3.7 Filter Cleaning	11
3.8 Charging after using	11
<b>4. Function Description</b>	<b>12</b>
4.1 Status Lights and Voice Interaction	12
4.2 Auto Mode	13
4.3 Manual Mode	15
<b>5. APP Instructions</b>	<b>17</b>
5.1 Download & Registration	17
5.2 Pairing with the robot	18
<b>6. Maintenance and Care</b>	<b>18</b>
6.1 Parts Maintenance	18
6.2 Component Maintenance	19
6.3 Filter Replace	20
<b>7. Product Storage</b>	<b>21</b>
<b>8. Common Troubleshooting</b>	<b>22</b>
<b>9. Warranty and After-sales</b>	<b>23</b>
9.1 Key Component Warranty Period	23
9.2 Other Warranty and After-sales Information	23

---

# 1. Safety Precautions

## 1.1 Warning

- Do not allow children to ride or play with the product.
- Store the product in a place inaccessible to children.
- This product is intended for use by individuals over 18 years old only.
- Under no circumstances should anyone insert their hands into the propeller.
- Do not use unofficially recommended or sold accessories.
- Use only original and authorized power adapters.
- When charging, the power adapter must be plugged into a socket with leakage protection.
- Do not operate the pool robot when there are people or animals in the pool.
- While charging, place the pool robot in a cool shaded area without any covering to prevent overheating and damage to internal electrical components.
- Only certified professionals should disassemble the pool robot's sealed core unit.
- Do not operate the pool robot while the pool filter is running.
- Use for daily pool cleaning and maintenance only; do not use it for newly-built pool first cleaning.
- The pool robot motor contains grease; if damaged, remove the robot from the pool and asked help from authorized dealer.
- If the pool robot needs to be stored long term, charge it every three months to maintain the battery capacity between 40% and 60% to prevent irreversible damage to the battery.
- Do not use or store the pool robot near any high-temperature heat sources.
- Do not puncture the pool robot's casing with nails or sharp objects.
- Avoid hammering, striking, or throwing the pool robot.
- Ensure the charging socket is dry before charging.

## 1.2 Notes

- This robot is designed to clean the pool bottom, walls, waterline, and can also clean the water surface with its skimmer.
- After use, make sure to clean and wash the filter thoroughly.
- When not in use, during maintenance, or cleaning, turn off the pool robot.
- Store the pool robot in a cool, ventilated area away from direct sunlight.

### 1.3 Water quality conditions

PH	7.0 to 7.8
Operating Temperature	5°C to 40°C
NaCl	Max 5000 PPM
Chlorine	Max 4 PPM

## 2.Product Unboxing

### 2.1 Unboxing Checklist

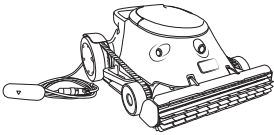

1×Robot ①

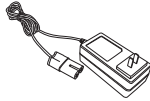

1×Charger



1×Remote Control

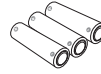

3× Remote control battery



1× Manual

- ① The filter comes with a standard 150µm filter screen, and includes one disposable 150µm filter screen as an extra.

The filter screen in the filter tank can be replaced with a HEPA filter (25µm).

## 2.2 Component Introduction

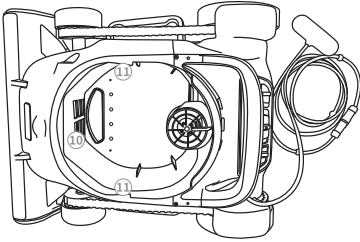
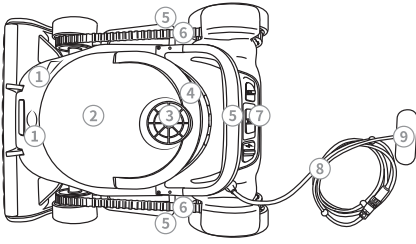

- 1) Ultrasonic module
- 2) Filter basket
- 3) Water dispenser cover / water outlet
- 4) Filter basket handle
- 5) Handles (left handle, right handle, rear handle)
- 6) Tracks
- 7) Control panel
- 8) Semi floating cable
- 9) Buoy handle
- 10) Outlet
- 11) Filter basket fixed structure

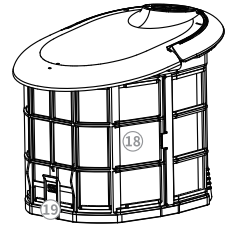
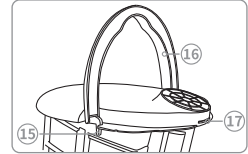
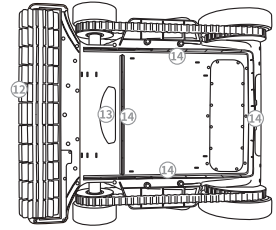

- 12) Rubber brush
- 13) Inlet
- 14) AquaFlow Brush
- 15) Filter basket bottom cover
- 16) Filter basket handle
- 17) Filter basket handle fixed structure
- 18) Filter basket
- 19) Filter basket bottom cover

## 2.3 Product Specifications

Product Information	Robotic Pool Cleaner
Product dimensions	550*430*262 mm (L×W×H)
Weight	9.4kg( ± 0.1)
Pool Depth	0.6m-2.3m(2ft-7.5ft)
Longest runtime for once	6h (Floor Mode Only)
Operating environment temperature	5°C to 40°C
Pool pH levels	7.0 to 7.8
Maximum pool tilt angle	15°
Storage temperature	-20°C to 45°C ,RH ≤ 75%
Cleaning module	
Cleaning power	Max100W
Filter basket capacity	6L
Particle filtration range	75μm (Using the standard filter and disposable filter bag.)
Pool coverage	Floor、 Wall、 Waterline、 Surface (with optional skimmer)
Cleaning modes	Auto/Manual
Cleaning speed	0.5m/s;30 m / min
Cleaning efficiency	12m <sup>2</sup> / min Or 600m <sup>2</sup> / h (This figure is only for reference. Actual figures for the cleaning area may vary from the shape of the pool.)
Smart features	
Path Planning	AdaptiveNav Path Planning 3.0
Full Bag Indicator	Supported
AdaptiveSuction Technology	Supported
Other features	
Ultrasonic	Supported (Dual)
Voice interaction	Supported
Battery	
Battery capacity	18000 mAh (333 Wh)
Nominal voltage	18.5V
Charging limit voltage	21V
Battery type	5S4P
Charging environment temperature	0°C to 40°C
Charging power	60W
Remote controller	
Remote control handle	Supported
Remote control handle longest battery life	≥ 50h
Maximum control distance	30m
Operating environment temperature	0°C to 40°C
APP	
APP	Supported
Connection method	Bluetooth + WiFi
APP Manual Mode	Supported
Real-time preview of cleaning status	Supported

## 3.Initial Use

### 3.1 Charging

Before use, please make sure to charge the pool robot.

- ① Remove the charging port plug.
- ② The charging head is designed for non-reversible insertion to ensure you connect it correctly.
- ③ Plug the power head into a socket (supports AC: 100-240V-50/60Hz).
  - will flash, indicating charging; a steady green ■ indicates charging completion.
  - The adapter's red light indicates charging, and the green light indicates charging completion.

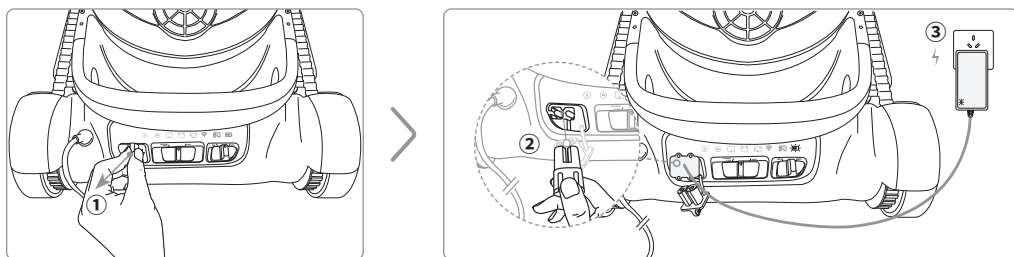

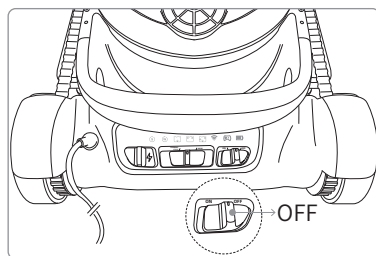
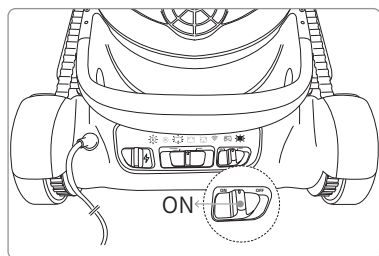

### 3.2 Turn On/Off

- Switch the power button to the "ON" position to turn on the device, which will also awake cleaning status light and battery indicator light.
- Switch the power button to the "OFF" position to turn off the device. The indicator lights will turn off.



### 3.3 Battery Level

When the pool robot is cleaning the pool, please pay attention to the battery level indicator. When the battery is low, make sure to recharge the pool robot promptly.

icon color	Battery Level	Status
 Green	$\geq 60\%$	The pool robot can operate normally.
 Yellow	20%~60%	The battery level is around 20% to 60%.
 Red	$\leq 20\%$	The pool robot has low battery and needs to be recharged.

**⚠ Note:** Please recharge the pool cleaning robot promptly when the battery level is  $\leq 20\%$  to prevent over-discharge of the battery.

### 3.4 Machine Water Entry

- Fully extend the semi floating cable to avoid tangling and knots.
- Check if the charging rubber plug is properly installed. After proper installation, put the robot in the pool for cleaning operation.

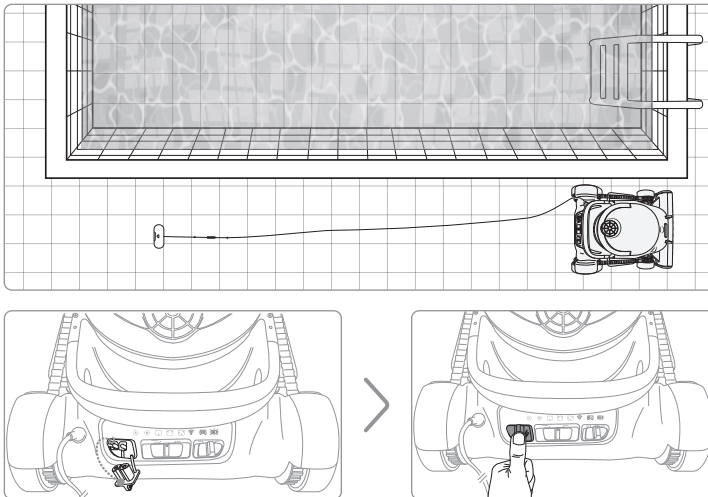

- 
- Switch the power button to "ON" to start the pool robot.
  - Grab the rear handle of the robot and place it in the water; the robot will automatically sink to the bottom of the pool.
  - Once reach to the pool bottom, the robot will start cleaning based on the chosen mode.

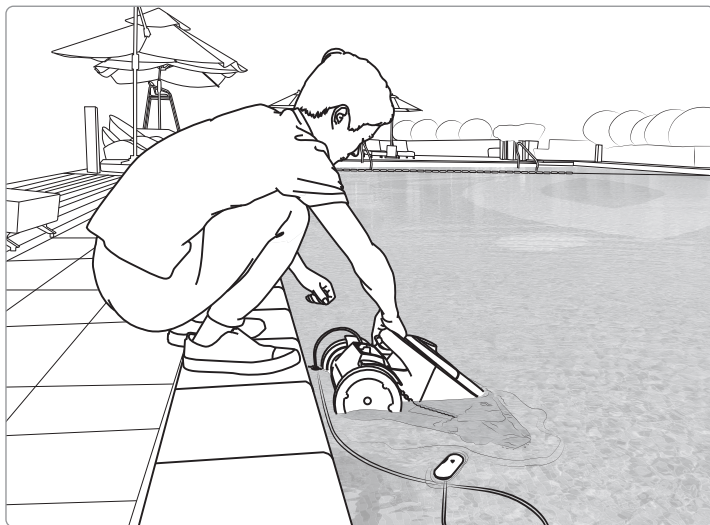

\* The pool cleaning robot, when fully charged, will start cleaning in the chosen cleaning mode upon entry into the water.

### 3.5 Auto Parking

After completing the cleaning task, robot will automatically go to the pool edge, waiting for instructions for the next cleaning task based on user's setting.

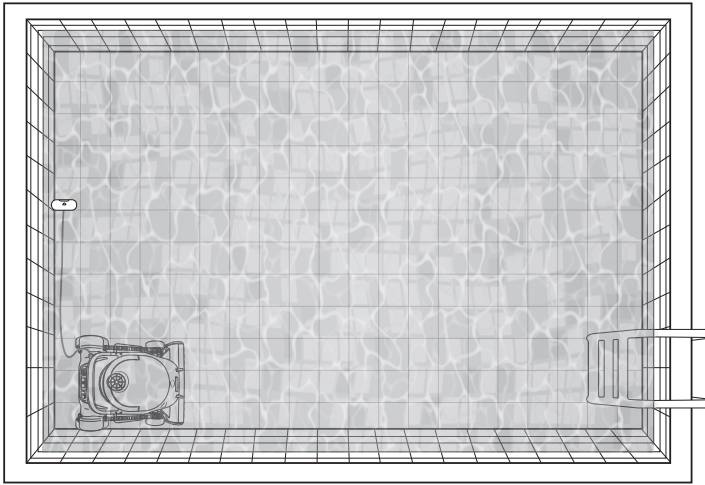

### 3.6 Waterline Retrieval

- You can use the "Lift" function in the app to control the robot to approach the water surface, or manually pull the semi floating cable to bring the robot to the water surface position.
- Grab the rear handle of the robot and lift it gently.
- Lift the pool robot out of the pool after the robot drained out the water.

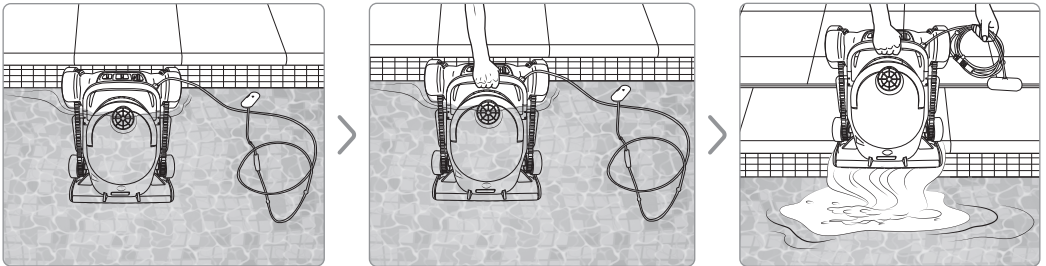

### 3.7 Filter Cleaning

- Take out the filter tank and open the bottom cover.
- Remove the disposable filter bag, clean and rinse the debris inside, and if the filter bag is heavily soiled, it is recommended to replace it.
- After emptying the remaining debris from the external filter basket, rinse it thoroughly using a hose or pressure washer.

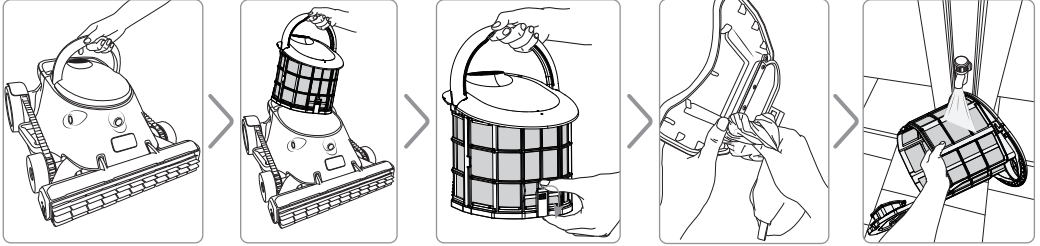

### 3.8 Charging after using

- After the pool robot has completed the cleaning, make sure to dry any water marks around the charging port with a dry towel before removing the charging port plug.

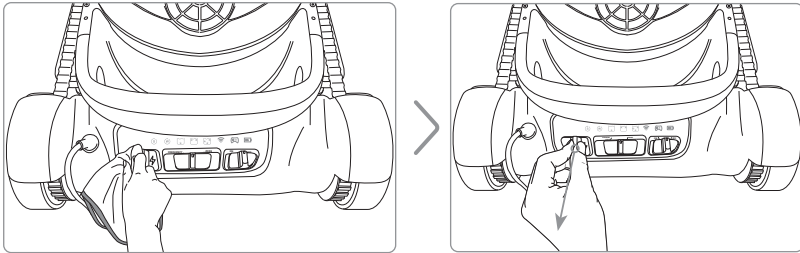

- The robot's charging port is designed to prevent reverse insertion. Please refer to the diagram below to charge the robot accordingly.

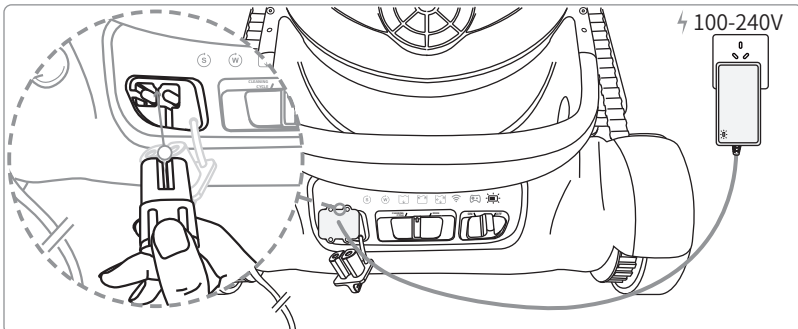

## 4. Function Description

### 4.1 Status Lights and Voice Interaction

Without app, you can switch cleaning modes by using the switch on the control panel.

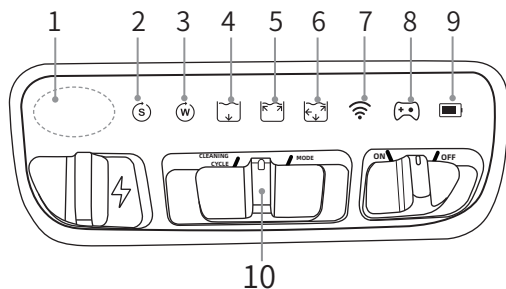

① When switching modes, there will be a corresponding voice reminder.

② When the robot is connected to the remote controller, the remote controller indicator light (🎮) will illuminate.

1) Voice<sup>①</sup>

2) Single cleaning indicator light

3) weekly mode indicator light

4) Pool bottom cleaning indicator light

5) Pool bottom cleaning indicator light

6) Wall + Waterline mode indicator light

7) Mobile phone connection indicator light

8) Remote control Indicator light<sup>②</sup>

9) Battery level indicator light

10) Switch between Single/Weekly mode

Status Light	Mode/Status	Voice Interaction	Explanation
Ⓢ	Single Cleaning Mode	Single Cleaning	The robot will clean for once.
Ⓦ	Weekly Mode	Periodic Cleaning	The robot will automatically perform cleaning according to the preset schedule.
🏊	Pool Bottom Mode	Pool Bottom Cleaning	The robot will only clean the pool bottom.
🏊	Waterline Mode	Pool Bottom and Waterline Cleaning	The robot will clean both the waterline and pool bottom of the pool.
🏊	Full Cleaning Mode	Full Cleaning	The robot will thoroughly clean the pool bottom, walls, and waterline.
📶	Mobile Connectivity	Mobile Connection	The robot is connected to the mobile app.
🎮	Remote Control Mode	Remote Control Mode	Using the remote control to operate the pool robot.
🔋	Red light on	Low battery, please charge	Warning when battery $\leq 20\%$
🔋	Yellow Light on	/	$20\% < \text{Battery Level} < 60\%$
🔋	Green Light on	/	Battery level $\geq 60\%$
🔋	Blinking Red Light	/	Charging: Battery level $\leq 20\%$
🔋	Blinking Yellow Light	/	Charging: $20\% < \text{Battery Level} < 60\%$
🔋	Blinking Green Light	/	Charging: Battery level $\geq 60\%$

## 4.2 Auto Mode

- Switch the button (see below picture) to the left, the pool robot will switch between Single and Weekly cleaning modes. The corresponding status light will illuminate, accompanied by a voice reminder.
- Switch the button (see below picture) to the right, the pool robot will switch between Pool Bottom, Waterline, and Full cleaning modes. The corresponding status lights will illuminate, accompanied by a voice reminder.

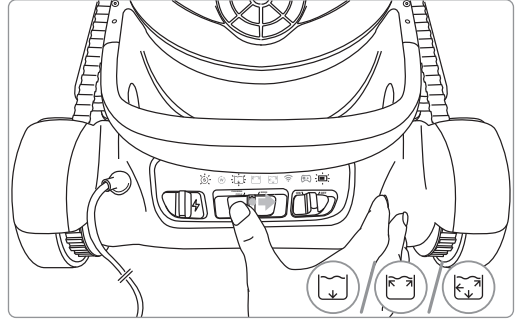
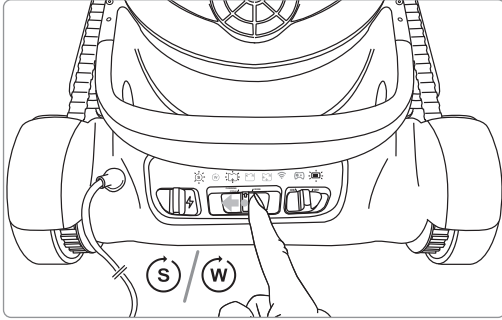

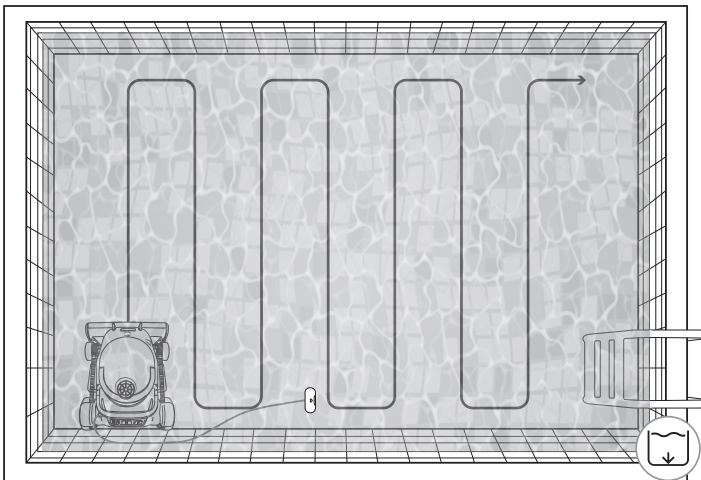

- After setting, place the pool robot in the pool, and it will automatically clean according to the set mode.
- In Pool Floor cleaning mode Mode “”, the cleaning actions are as follows: The pool robot will clean the pool floor along a designated path.

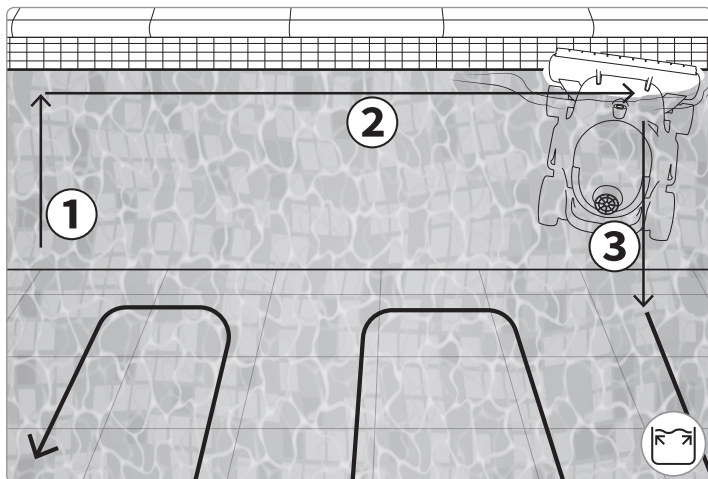

• In Waterline Mode (  ), the cleaning actions are as follows:

- ① Climbing up for cleaning;
- ② Moving horizontally along the waterline for cleaning;
- ③ After cleaning the waterline, the robot will return to the pool floor and also clean the pool floor.



• In the Full Cleaning Mode (  ), the pool robot will clean the walls and waterline first before proceeding to clean the pool floor.

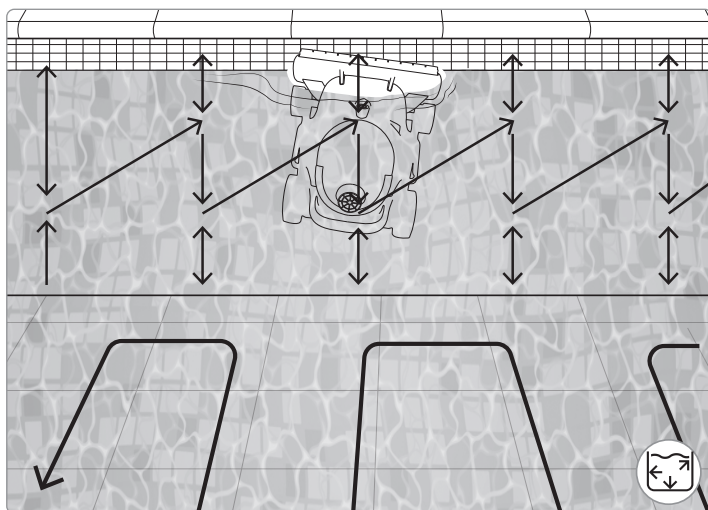

## 4.3 Manual Mode

You can control the pool robot manually using the remote controller or the Manual Mode \* in the app.

Introduction to the remote controller components and battery installation;

The remote controller requires three AA batteries (these batteries are non-rechargeable), follow the diagram for installation:

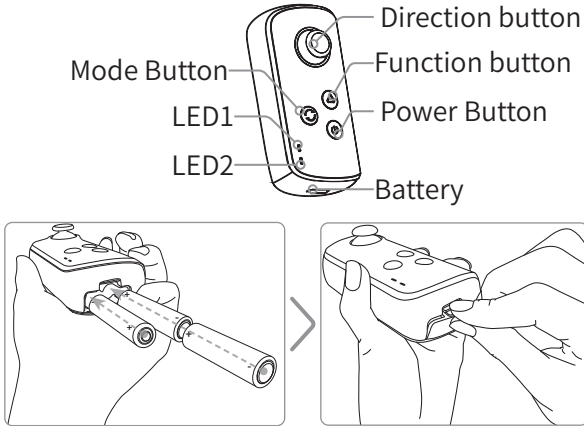

Component	Controls and Status	Explanation
⊕ Direction button	Forward/Backward	Controlling the robot's forward/backward movement
	Left/Right	Controlling the robot's turning
⊙ Function Button	Short press to switch roller brush speed	Roller brush control settings include two speeds: high speed and regular speed. In auto mode, high speed is for waterline, climbing walls, and corners, while regular speed is for pool bottom cleaning.
⊙ Mode Button	Switch control mode	Switching between preset auto mode or manual mode (Auto mode/RC mode)
⊙ Power Button	Long press for 2 seconds to power on/off	Powering on accompanied by buzzer "Beep-Beep" sound
	Single press of a button	In auto mode, the robot pauses its current task, shutting off all motors; in manual mode, the water pump motor and roller brush motor pause.

Component	Controls and Status	Explanation
LED 1 Robot Status	Solid green light	Manual mode + Robot is working
	Flashing green light	Manual mode + Robot is not working
	Solid blue light	Auto mode status + Robot is working
	Flashing blue light	Auto mode status + Robot is not working
	Light off	The robot fails to transmit the current status back to the remote control
LED 2 Remote Control Status	Flashing red light	Remote control is in search/connecting with robot status
	Solid red light	Low battery in remote control (accompanied by buzzer "Beep-Beep-Beep" alert)
	Light off	Normal state of remote control (normal battery + normal connection)
Buzzer	"Beep" single alert tone	Remote control power on/off prompt
	"Beep-Beep-Beep" tone, repeating every 10 seconds	Low battery in remote control with light change to remind for battery replacement 5 minutes of remote control inactivity prompts user to turn off; if not operated for 6 minutes, the remote control automatically shuts down.
Function button + Power button Combination	Simultaneous long press <b>[Function Key + Power Key]</b> for 2 seconds to enter joystick calibration mode	Successful startup in remote control triggers "Beep-Beep" alert. Full rotation of the joystick for front/back/left/right signals calibrate
	Double-click the Function Switch Button	Exit calibration mode, successful exit prompts "Beep-Beep" in remote control; LED alternates between blue and green lights quickly (5Hz frequency).
Mode Switch button + On/ Off button	Press and hold the [Mode Switch button + On/Off button] for 2 seconds to enter the pairing operation	After successful startup, the remote control prompts with a "beep-beep-beep" sound, and the LED flashes blue and green alternately and slowly (frequency: 1Hz); Successful pairing: After entering the pairing mode, the remote control automatically searches for devices with a special Bluetooth name. Once the pairing information is met, it will automatically connect to the device and remember this connection. It can only remember and connect to one robot, overwriting any existing pairing information.
		Failed pairing: If pairing is not successful within 60 seconds, the remote control will automatically exit the pairing state.
		After the first successful pairing, the remote control automatically switches to the manual mode + robot idle state, and synchronously issues commands to the robot.

The remote controller's joystick is a self-returning joystick. When you release the joystick after moving it, the joystick will automatically return to the center position. Remote control operation and the robot's response:

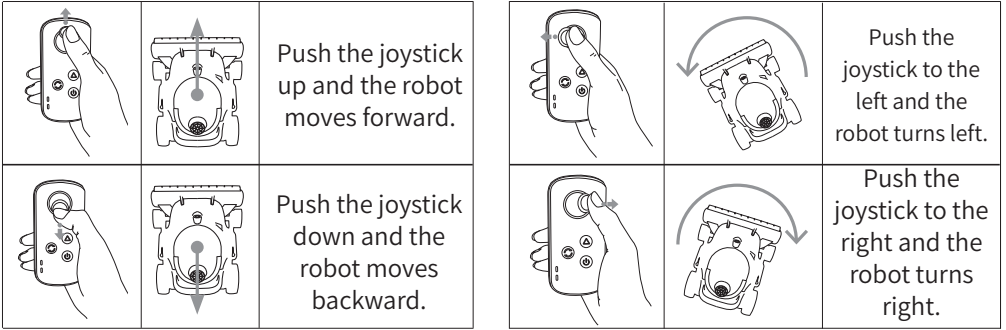

## 5.APP Instructions

The robot supports connecting to the APP to manage the pool robot.

Through the APP, you can access the following services:

- Manage the pool robot and software upgrades.
- Obtain maintenance tips for the pool and the robot for better pool management.
- Contact the official support team to receive timely technical assistance.

### 5.1 Download & Registration

Before the initial use, you can scan the QR code to download the App from the App Store, Google Play, or the official website, and then follow the prompts to register/login with your account. Please refer to the final QR code on the official website.

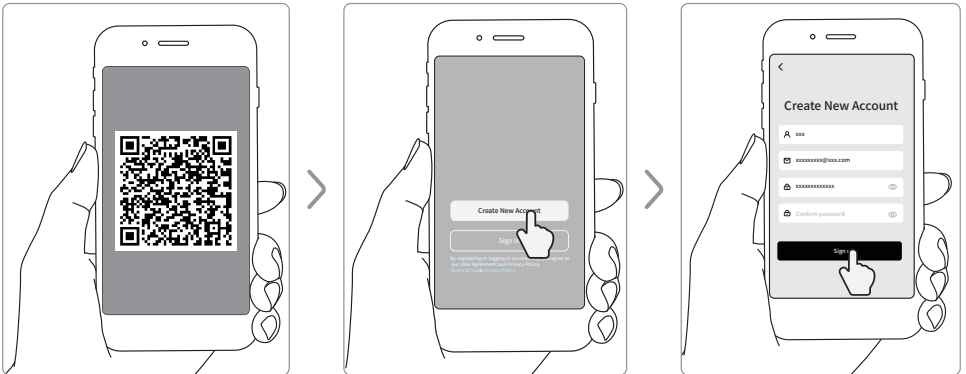

## 5.2 Pairing with the robot

To set up your pool robot, open the App, click on " + Add New Device," and "allow" Bluetooth and location access on your phone. Once you enter the search page and see the related product names on the list, select your purchased product to complete the initial pairing process.

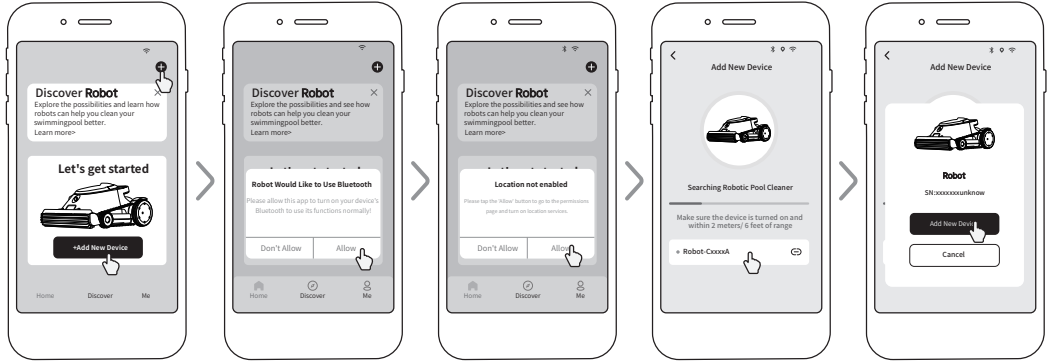

## 6. Maintenance and Care

### 6.1 Parts Maintenance

After robot completing pool cleaning, rinse it and clean the sand and debris in the filter basket installation groove, roller brush and rubber strip.

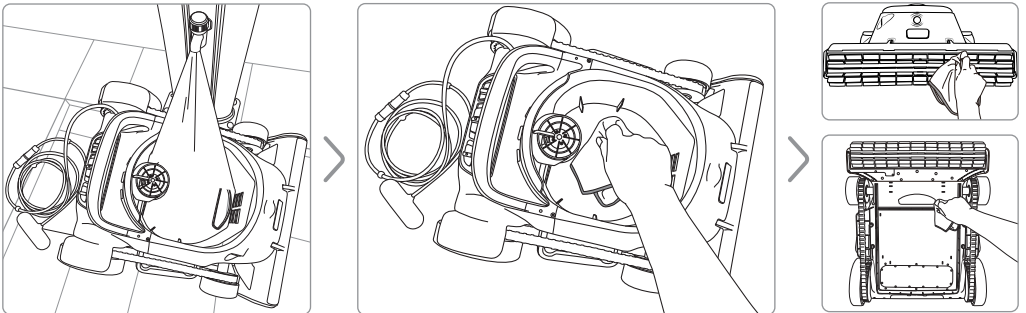

## 6.2 Component Maintenance

To ensure the cleaning efficiency of the pool robot, it is recommended that you pay attention to the following components:

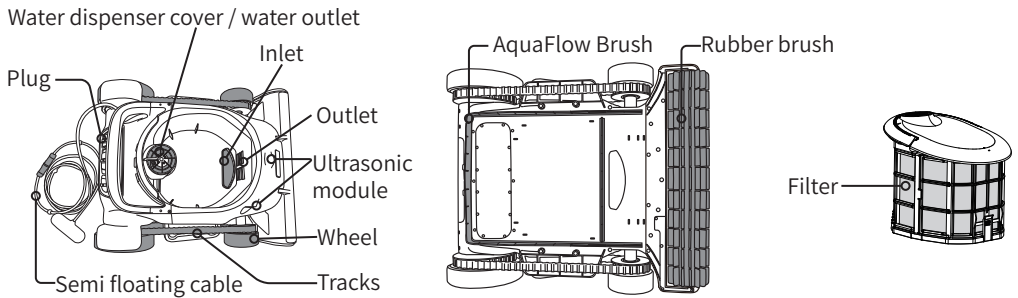

- Check if there is any debris on the water propeller. If there is debris, clean it promptly. Ensure the robot is powered off when cleaning the water propeller.
- Inspect the inlet and outlet for any blockages; clear them if there are any.
- Check if the ultrasonic sensor is obstructed; wipe it clean if any objects are blocking it.
- Check for any damage to the semi floating cable; contact customer support promptly if any damage is found.
- Inspect the charging port plug for any damage; contact customer support if there is any damage.
- Check if the tracks are loose; if so, reset them promptly.
- Inspect the condition of the front and rear tires; if severe wear affects cleaning and movement, purchase replacement parts from the authorized dealer and seek guidance for correct replacement.
- Check the wear of the rubber brush and roller brush; if severe wear affects cleaning and movement, purchase replacement parts from the official store and seek guidance for correct replacement.
- Check if the filter is damaged; replace the filter basket promptly if any damage is found.

For significant wear or damage, do not attempt to repair the pool robot yourself. Contact our after-sales technical staff for assistance.

## 6.3 Filter Replace

To remove the filter, follow these steps:

- ① Open the bottom shell.
- ② Pull apart the C-shaped fasteners on both sides of the bottom shell.
- ③ Grab the handle of the filter basket on both ends and pull outward forcefully (Note: Do not pull both sides at the same time, take out side A first and then side B).

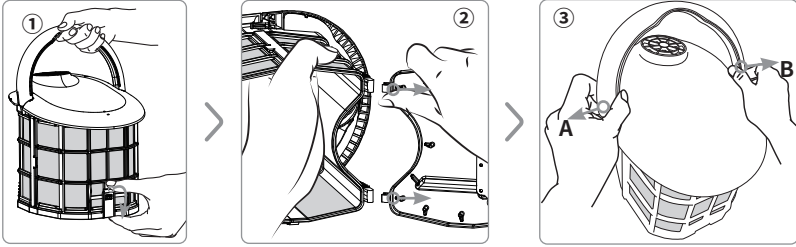

- ④ Remove the handle of the filter basket.
- ⑤ Apply outward force at the location of the top cover's clip.
- ⑥ Separate the top cover of the filter basket.

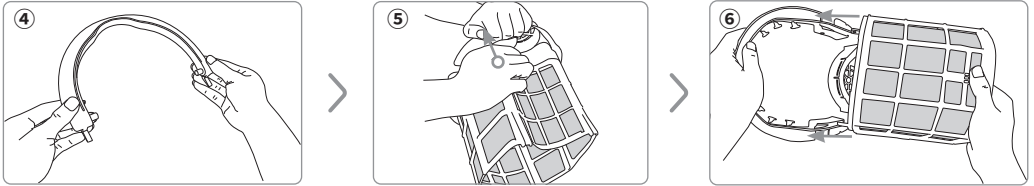

To replace the new filter basket, follow the reverse steps from the disassembly process:

- ① Align the clips to install the filter basket with the water tank's top cover.
- ② Align the installation holes to attach the handle of the filter basket (Do not pull both sides apart at the same time for installation, install the A side first and then the B side).
- ③ Replace the disposable filter bag and install the bottom shell C-shaped fasteners.
- ④ After installing the filter basket back on the pool robot, make sure the handle of the filter basket is laid flat.
- ⑤ Press the handle into place to prevent it from lifting during pool cleaning.

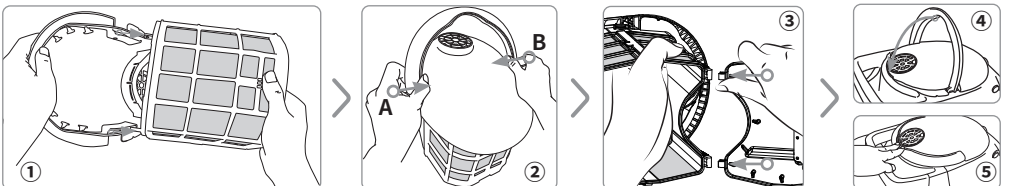

## 7. Product Storage

When not using the pool robot for an extended period, store it in a dry and cool place.

- Make sure the robot is powered off.
- Ensure there is no water residue in the robot and keep it dry.
- Thoroughly clean the robot and filter basket, wipe the body, metal interfaces of the buoy handle, and semi floating cable with a dry towel.
- Disassemble the filter basket completely and let it air dry in a ventilated area.
- Store the pool robot in a place shielded from direct sunlight, rain, or frost.
- Before storage, fully charge the pool robot and recharge it every three months to maintain the battery capacity between 40%-60%.
- During winter, store the pool robot indoors to protect the battery.

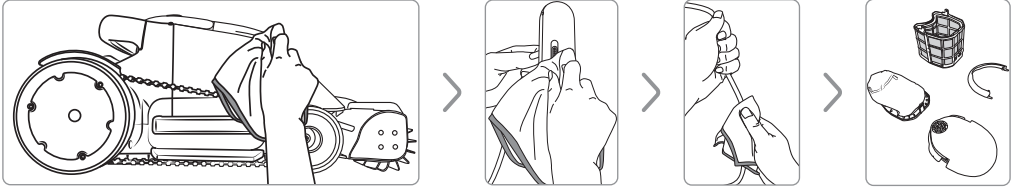

## 8.Common Troubleshooting

Symptoms	Troubleshooting Steps
Robot won't power on	Charge the robot and check if the battery indicator light is blinking normally. After charging, try to turn it on again.
Remote control cannot operate the robot	<ol style="list-style-type: none"><li>1. Check if the remote control is powered on and in working condition;</li><li>2. Verify if it is properly connected with the robot.</li></ol>
Robot won't connect to the app	<ol style="list-style-type: none"><li>1. Ensure the robot is powered on;</li><li>2. Check if it is correctly paired with the app;</li><li>3. Try connecting via the remote control to confirm functionality.</li></ol>
Robot starts but doesn't work	<ol style="list-style-type: none"><li>1. Remove the robot from the pool.</li><li>2. Check if the robot's battery indicator turns red.</li><li>3. Connect to the robot via the app for self-diagnostics.</li></ol>
Robot moves slowly	<ol style="list-style-type: none"><li>1. Remove the robot from the pool.</li><li>2. Clean the filter basket of debris.</li><li>3. Power off the robot, lay it on its side, and check if the rear wheels can move freely.</li></ol>
Robot can't climb walls	<ol style="list-style-type: none"><li>1. Remove the robot from the pool.</li><li>2. Clean the filter basket of debris.</li><li>3. Power off the robot, lie it on its side, and check if the rear wheels can move freely.</li></ol>
Robot's cleaning effectiveness is poor	<ol style="list-style-type: none"><li>1. Remove the robot from the pool.</li><li>2. Clean the filter basket of debris.</li></ol>

## 9. Warranty and After-sales

### 9.1 Key Component Warranty Period

Component	North America	EU	Australia	China	Others
Main unit (including battery)	2	2	2	2	2
Roller brush (wearable part)	No warranty	No warranty	No warranty	No warranty	No warranty
Filter assembly (wearable part)	No warranty	No warranty	No warranty	No warranty	No warranty
Wheel assembly (wearable part)	No warranty	No warranty	No warranty	No warranty	No warranty
Tread (wearable part)	No warranty	No warranty	No warranty	No warranty	No warranty

### 9.2 Other Warranty and After-sales Information

The product has undergone all quality control and safety tests conducted by the factory's technical department and complies with relevant legal requirements.

Warranty Information:

- The warranty is void if the product is altered, misused, or repaired by unauthorized personnel.
- The warranty covers manufacturing defects only and does not include any damage resulting from improper handling by the owner.
- Any claims or repairs within the warranty period must provide an order number or other relevant records.